

# USB CONNECTOR

部品番号  
Part No.

YKF45-0080N

USB 3.2 (Gen2)準拠 Type C 24P (RA)

## ■一般仕様

- ・定格
  - 30V AC
  - 5A(Vbus)
  - 1.25A(Vconn, GND)
  - 0.25A(その他)
- ・耐電圧
  - 100V AC 1分
- ・絶縁抵抗
  - 100V DC 1,000MΩ以上
- ・接触抵抗
  - 40mΩ以下(100mA以下)
- ・動作耐久性
  - 10,000回
- ・使用温度範囲
  - 20°C~+60°C

## ■General Specification

- ・Rating
  - 30V AC
  - 5A(Vbus)
  - 1.25A(Vconn, GND)
  - 0.25A(Others)
- ・Withstanding valtage
  - 100V AC 1minute
- ・Insulation resistance
  - 100V DC 1,000MΩ min.
- ・Contact resistance
  - 40mΩ max
- ・Durability
  - 10,000 times
- ・Practical temp
  - 20°C~+60°C

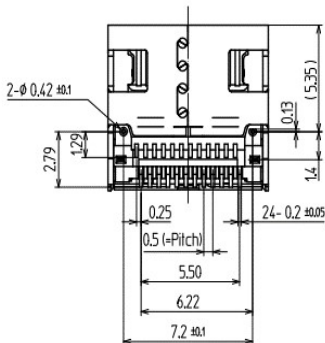
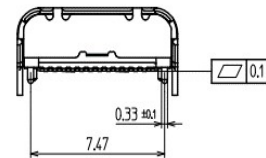
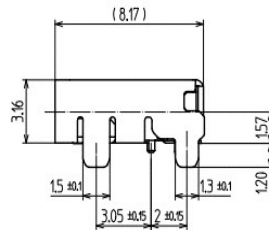
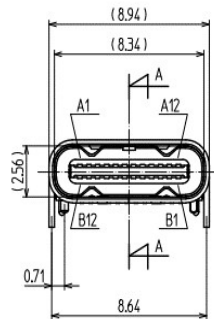
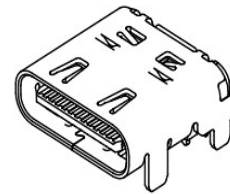
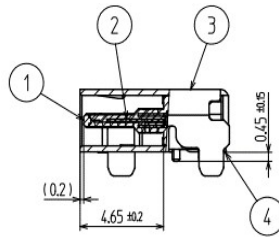
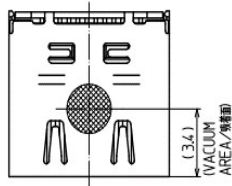

\* 製品改良などにより記載性能、仕様の一部を予告なく変更する場合があります。

\* As products are improved, changes may occur. Thus, specifications in directions are subject to change without previous notificatons.

## 東北タツミ株式会社

〒101-0021東京都千代田区外神田二丁目4-4 第1電波ビル1F  
TEL.(03)5577-5831 FAX.(03)5577-5832  
E-mail:info@t-tatsumi.com  
URL:http://www.t-tatsumi.com

## TOHOKU TATSUMI CO., LTD.

2-4-4, Soto-Kanda, Chiyoda-ku, Tokyo, 101-0021, Japan,  
Daiichidenpa building 1F  
E-mail:info@t-tatsumi.com  
URL:http://www.t-tatsumi.com