

A-A Sec / 断面図

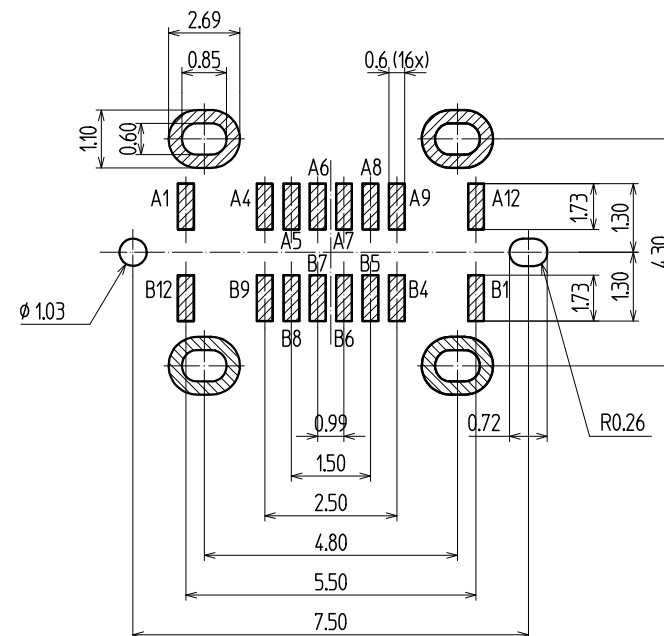

PC BOARD LAYOUT/参考基板孔寸法図 t0.8 (S=10/1)  
(Tolerance/公差 ALL±005)(Parts Side/部品面)

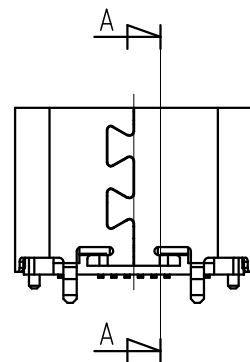
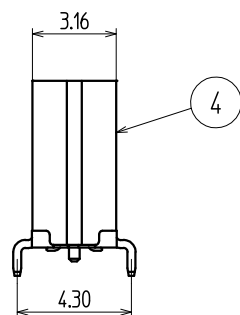
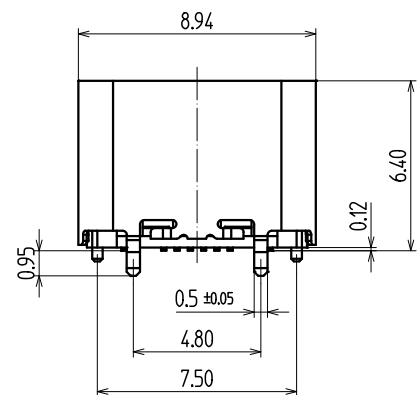
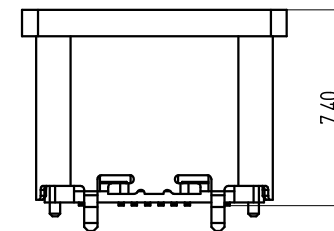
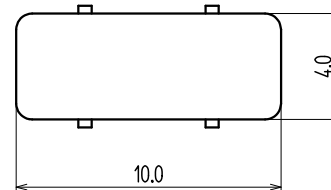
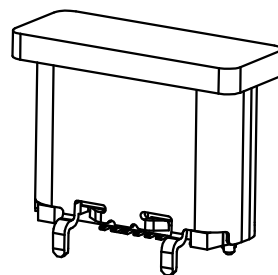
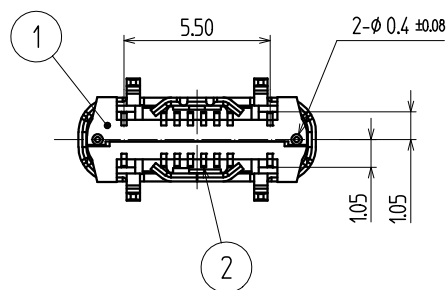

NOTE / 注記

- 1. UNDER PLATED : Ni
- CONTACT AREA : Au Flash
- SOLDERING AREA : Au
- 下地めっき : Ni
- 接触部めっき : Au Flash
- 半田付部めっき : Au

4	SHELL シェル	1	STAINLESS ステンレス					Ni 30μ inch Ni 30μインチ	
3	MID PLATE ミッドプレート	1	STAINLESS ステンレス					NOTE 1 注記 1	
2	TERMINAL ターミナル	16	COPPER ALLOY 銅合金						
1	HOUSING ハウジング	1	LCP BLACK/黒				94V-0		
No. 品番	PARTS NAME 名称	QTY 個数	MATERIAL 材質	MAKER メーカー名	No.	UL	FINISH 処理	REMARKS 備考	ISSUED 出図

TOLERANCE 寸法公差		X							
X.	± 0.5	X							
XX	± 0.35	X							
XXX	± 0.25	X							
	±	X							
ANGLE	± 2°		MARK 記号						
	REVISIONS 改訂事項			DATE 日付	SIGN 担当				

ALL DIMENSIONS IN ( ) ARE FOR REFERENCES ONLY ( )印は、参考寸法				TITLE 名称 USB TYPEC USB タイプC		ISSUED 出図
APPROVED 責任者	CHECKED 検査者	DRAWN 製図者	DESIGNED 設計者	CODE No. コードNo. YKF45-0084N		
				DRAWING No. 図番		
				UNIT 単位 mm		
				SCALE 尺度 5/1		REVISION 版数
				CUSTOMER CODE ユーザーコード		

TOHOKU TATSUMI,CO.LTD.