

あなたの情報を繋ぐ。

Plug your life

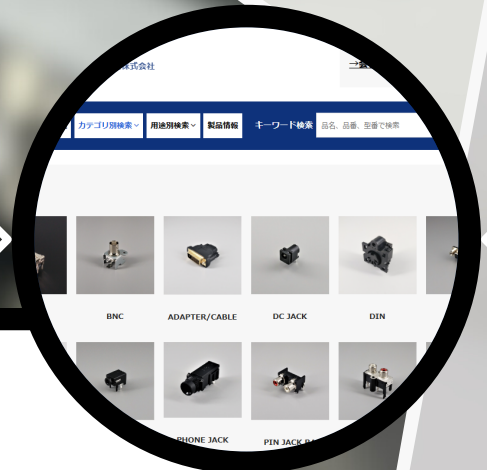

東北タツミ株式会社











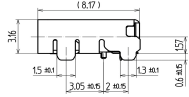

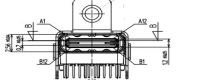

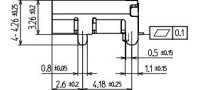

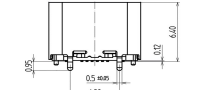

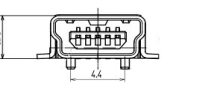

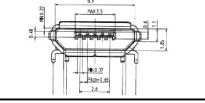

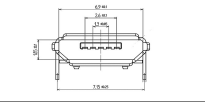

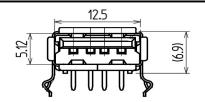

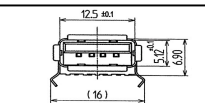

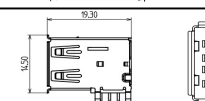

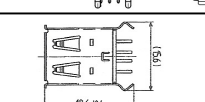

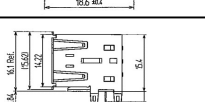

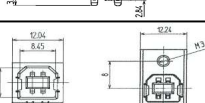
# PRODUCTS GUIDE

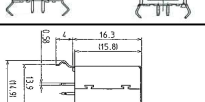
1) USB CONNECTOR	P-1
2) HDMI CONNECTOR	P-2
3) DVI CONNECTOR	P-2
4) D-sub CONNECTOR	P-3
5) MINI DIN CONNECTOR	P-4
6) DIN CONNECTOR	P-4
7) XLR CONNECTOR	P-4
8) DC POWER JACK	P-5
9) PHONE JACK	P-6
10) MINIATURE JACK	P-7
11) PIN JACK	P-8
12) BNC CONNECTOR	P-8
13) CABLE、 CONVERSION ADAPTER	P-9
14) METAL PARTS	P-9

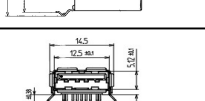
以外にカスタムでの生産も承っております



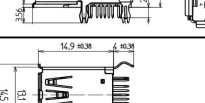

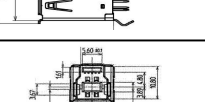





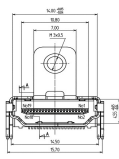

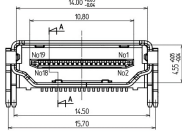
**PRODUCT LIST**

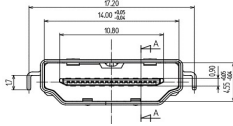
**1) USB CONNECTOR**

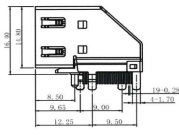

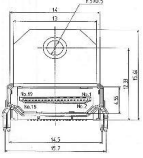

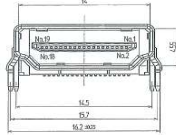
USB 3.2 (GEN2)準拠 Type C RA 24P			YKF45-0080N
USB 3.2 (GEN2)準拠 Type C 24P RA Hybrid Terminal			YKF45-0079N
USB 2.0準拠 Type C RA 16P			YKF45-0076N
USB 2.0準拠 Type C VT 16P	New release 		YKF45-0084N
USB MiniB RA			YKF45-0037N
USB MicroB RA			KF0101A05EK4
USB MicroB RA Long terminal			YKF45-0078N
USB2.0 A RA			YKF45-0033N
USB2.0 A RA SMD (4P)			YKF45-0067N
USB2.0 A UR			YKF45-0053N
USB2.0 A VT			YKF45-0063N
USB2.0 A RA DUAL			YKF45-0038N
USB2.0 B RA			YKF45-0002N (WHITE) YKF45-0020N (FLANGE) YKF45-0021N
USB2.0 B VT			YKF45-0016P
USB3.0 A RA			YKF45-0065N
USB3.0 A UR			YKF45-0052N
USB3.0 A VT			YKF45-0066N
USB3.0 B RA			YKF45-0055N

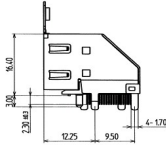
**PRODUCT LIST**

**2) HDMI CONNECTOR**

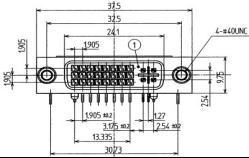
RIGHT ANGLE WITH FLANGE	New release 		HDMI 2.1規格認証コネクタ(48Gbps伝送) YKF45-7108N
RIGHT ANGLE	New release 		HDMI 2.1規格認証コネクタ(48Gbps伝送) YKF45-7107N
MID MOUNT	New release 		HDMI 2.1規格認証コネクタ(48Gbps伝送) YKF45-7102N
UPRIGHT	New release 		HDMI 2.1規格認証コネクタ(48Gbps伝送) YKF45-7109N
RIGHT ANGLE WITH FLANGE			KF0351A19EK2
RIGHT ANGLE			YKF45-7096N
UPRIGHT			YKF45-7097N

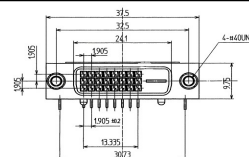
**3) DVI CONNECTOR**

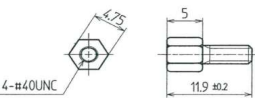
DVI-I			YKF45-7101P YKF45-7101P+ (+ : inch screw included)
DVI-D			YKF45-7100P YKF45-7100P+ (+ : inch screw included)
INCH SCREW			

**PRODUCT LIST**

**4) D-sub CONNECTOR**

			POLES	WITHOUT SCREW	WITH SCREW #4-40 UNC
9P/15P/25P RA			9	YKF42-8087N	YKF42-8093N
			15	YKF42-8098N	YKF42-8094N
			25	YKF42-8088N	YKF42-8095N
9P/15P/25P PLUG RA			9	YKG42-7200N	YKF42-7203N
			15	YKF52-7209N	YKF42-7204N
			25	YKF42-7210N	YKF42-7205N
9P/15P/25P VT			9	YKF42-8099N	YKF42-8096N
			15	YKF42-8100N	YKF42-8097N
			25	YKF42-8101N	YKF42-8089N
9P/15P/25P PLUG VT			9	YKF42-7211N	YKF42-7206N
			15	YKF42-7212N	YKF42-7207N
			25	YKF42-7213N	YKF42-7208N
15P (High Density) RA			15	YKF42-8102N	YKF42-8091N
15P PLUG (High Density) RA			15	YKF42-7214N	YKF42-7201N
15P (High Density) VT			15	YKF42-8103N	YKF42-8092N
15P PLUG (High Density) VT			15	YKF42-7215N	YKF42-7202N

PRODUCT LIST



**5) MINI DIN CONNECTOR**

6P		YKF51-5077V
6P		YKF51-5078V
8P		YKF45-5449N

カスタム品の設計・生産も承ります



We also accept requests for design and production of custom products.

**6) DIN CONNECTOR**

		POLES	SHIELD PLATE	BOSS	EARTH	
ORIGINAL DIRECTION		3P	-	○	-	YKF51-5043V
			○	○	-	YKF51-5047V
			-	-	○	YKF51-5050V
		5P	-	-	○	YKF51-5032V
			-	○	○	YKF51-5066V
			○	○	○	YKF51-5061V
8P	-	○	○	YKF51-5001V		
	○	○	○	YKF51-5031V		
REVERSE DIRECTION		3P	-	-	○	YKF51-5035V
			-	○	-	YKF51-5065V
			○	○	○	YKF51-5067V
		5P	○	○	○	YKF51-5030V
			○	○	○	YKF51-5069V
			○	○	○	YKF51-5069V

2連、3連につきましては弊社営業にお問合せお願い致します  
Please contact our sales office for 2 or 3 stations.

**7) XLR CONNECTOR**

		EARTH	CONTACT		OUTER CONTACT		
			Sn	Au	Ni	Au	
① PLUG		-	○	-	-	-	YKF52-5002V
		-	-	○	-	-	YKF52-5010V
		○	○	-	-	-	YKF52-5003V
		○	-	○	-	-	YKF52-5004V
② PLUG		-	-	○	-	-	YKV11-0494N
③ SOCKET		-	○	-	○	-	YKF52-5007V
		○	○	-	○	-	YKF52-5005V
		○	-	○	-	○	YKF52-5006V



**PRODUCT LIST**

**9) PHONE JACK (Φ6.5mm)**

	SLEEVE	MONO		STEREO	
		2A	2B	3A	3Z
① PJ 3 SERIES	—	YKB21-5014	YKB21-5012	YKB21-5010	YKB21-5074
	Ni	YKB21-5013	YKB21-5011	YKB21-5009	YKB21-5166
	Au	—	YKB21-5176	YKB21-5138	YKB21-5248
① PJ 3 SERIES (Terminal: Crab foot shape)	—	—	YKB21-5231	YKB21-5261	YKB21-5262
	Ni	—	—	YKB21-5265	YKB21-5288
	Au	—	YKB21-5466	YKB21-5266	YKB21-5267
		—	—	YKB21-5302 <small>(端子: 魚メッキ)</small>	—

	SLEEVE	MONO		STEREO	
		2D	2E	3C	3E
② PJ 9 SERIES	—	YKB211-5018	YKB21-5076	YKB21-5006	YKB21-5078
	Ni	YKB211-5017	YKB21-5075	YKB21-5005	YKB21-5077
	Au	YKB21-5139	YKB21-5218	YKB21-5153	YKB21-5209

	SLEEVE	MONO		STEREO	
		2A	2B	3A	3Z
③ PX 3 SERIES	—	—	—	—	YKB21-5320
	Ni	—	—	—	YKB21-5321
	Au	—	—	—	YKB21-5317

	SLEEVE	MONO		STEREO
		2A	2B	3A
④ PJ4 SERIES	Ni	—	—	YKB1-5455N

【NOTE】Accessories: Nut, Washer

	SLEEVE	MONO		STEREO
		2A	2B	3Z
⑤ PJ5 SERIES	Ni	—	—	KB0391A04AK2

	SLEEVE	MONO		STEREO
		2A	2B	3Z
⑤ PJ5 SERIES	Ni	—	—	YKB21-5458N

**PRODUCT LIST**

**10) MINIATURE JACK (Φ3.5mm)**

	SLEEVE	MONO		STEREO						REMARKS	
		2A	2B	3A	3C	3E	4A	4B	4Z		
⑤ MJ3 SERIES		—	YKB21-5291W	YKB21-5289W	YKB21-5290W	—	—	—	—	—	H=6.5mm
		Ni	YKB21-5293W	YKB21-5294W	YKB21-5295W	—	—	—	—	—	H=6.5mm
		Au	—	YKB21-5296V	YKB21-5292V	—	—	—	—	—	H=6.5mm
⑥ SJ7 SERIES		—	—	—	—	—	—	YKB21-5471N	YKB21-5457N	—	H=2.25mm
		—	—	—	—	—	—	—	YKB21-5467N	—	H=2.25mm
		—	—	—	—	—	—	—	—	—	—
⑦ SJ9 SERIES		—	—	—	YKB21-5406N	YKB21-5352N	YKB21-5344N	—	—	—	H=6.5mm
		Ni	—	—	YKB21-5413N	YKB21-5343N	YKB21-5345N	—	—	—	H=6.5mm
		Au	—	—	YKB21-5414N	YKB21-5399N	YKB21-5398N	—	—	—	H=6.5mm
① S3B SERIES		—	—	—	YKB21-5359N	—	—	—	—	—	H=8.3mm
		Ni	—	—	YKB21-5340V	—	—	—	—	—	H=8.3mm
		Au	—	—	YKB21-5327V	—	—	—	—	—	H=8.3mm
② S4B		—	—	—	—	—	—	YKB21-5366W	—	—	H=8.3mm
③ S3A SERIES		—	YKB21-5164V	YKB21-5165V	YKB21-5157V	—	—	—	—	—	H=10.5mm
		—	YKB21-5206V	YKB21-5205V	YKB21-5204V	—	—	—	—	—	—
④ S5A SERIES		—	—	—	—	YKB21-5481N	—	—	—	—	H=19.8mm
		—	—	—	—	YKB21-5488N	—	—	—	—	H=19.8mm (NO SCREW THREAD)
⑨ LA4 SERIES		—	—	—	YKB21-5274B	—	—	YKB21-5263B	—	—	H=2.5mm (KINK)
		—	—	—	YKB21-5298	—	—	YKB21-5347	—	—	H=2.5mm (STRAIGHT)
⑧ LA7		—	—	—	—	—	—	—	—	YKB21-5349	H=2.5mm







カスタム品の設計・生産も承ります





We also accept requests for design and production of custom products.



**PRODUCT LIST**



**11) PIN JACK**

		A Type Insulation with housing	Cタイプ Front shield	Gタイプ With switch option
14x14 series 1L1P		YKC21-3048V	YKC21-3891V	YLC21-3131V
14x14 series 1L2P		YKC21-3120V	YKC21-4133V	—
14x14 series 1L3P		YKC21-3058V	YKC21-4033V	YKC21-4391W
14x14 series 2L2P		YKC21-3035V	YKC21-4042V	YKC21-4707W
14x14 series 2L4P		YKC21-3034V	YKC21-3884V	YLC21-3126W
14x14 series 2L6P		YKC21-3089V	YKC21-3866V	YLC21-3145W

		SHIELD	SWITCH	
2P/14 VT		○	○	YKC21-6123V
		-	○	YKC21-6147V
3P/14 VT		-	○	YKV21-6120V
		-	-	YKC21-6127V
2P/15 RA		-	○	YKC21-5224V
		-	-	YKC21-6150V
1P RA		-	○	YKB11-0273A
		-	-	YKB11-0944V

配色・スイッチ位置のバリエーションは弊社営業にお問合せお願い致します  
 カスタム品の設計・生産も承ります  
 Please contact our sales office for variations in color scheme and switch position.  
 We also accept requests for design and production of custom products.

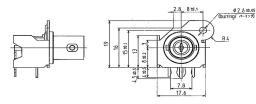
**12) BNC CONNECTOR**

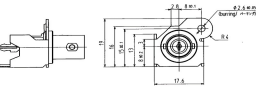

			WITH SWITCH	WITHOUT SWITCH
① RIGHT ANGLE			YKC31-0155	YKC31-0193
② VERTICAL			YKC31-0160	YKC31-0173

**PRODUCT LIST**

**13) CABLE、CONVERSION ADAPTER**

USB CABLE C (M)-C (M)		
USB CABLE 2.0A (M)-C (M)		
USB CABLE 2.1A (F)-C (M)		
USB CABLE A (M)-B (M)		
D-sub CABLE 9p (M)-9p (M)		
CONVERSION ADAPTER DVI-I(F)-HDMI(M)		
CONVERSION ADAPTER DVI-D(M)-HDMI(F)		

**14) METAL PARTS**

FUSE CLIP (TAPING)		CNT47-0003A
GROUND TERMINAL (TAPING)		MET37-0002
GROUND TERMINAL (TAPING)		MET37-0005

カスタム品の設計・生産も承ります  
We also accept requests for design and production of custom products.

この商品カタログに記載された内容は予告なしに更新、変更または削除されることがありますので、予めご了承ください  
Please note that the contents of this product catalog may be updated, changed or deleted without prior notice.