



HDMI CONNECTOR

部品番号
Part No.

YKF45-7097N

HDMI 1.4規格認証コネクタ(10.2Gbps伝送)

■一般仕様

- ・定格 40V a.c. 0.5A a.c.
- ・接触抵抗 10mΩ以下(電圧降下法)
- ・耐電圧 500V a.c. (未嵌合)
- ・絶縁抵抗 500V d.c. (未嵌合)
- ・動作耐久性 10,000回
- ・TMS信号TDインピーダンス 100Ω±15% (差動測定)
- ・使用温度範囲 -40°C~+85°C

■General Specification

- ・Rating 40V a.c. 0.5A a.c.
- ・Contact resistance(Terminal) 10mΩ max(with voltage crop)
- ・Withstanding voltage 500V a.c. (Unmated)
- ・Insulation resistance 500V d.c. (Unmated)
- ・Durability 10,000 times
- ・TMS signals TD Impedance 100Ω±15% (Defferential)
- ・Practical temp.range -40°C~+85°C

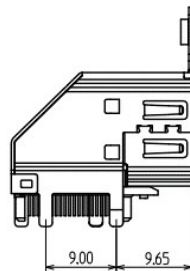
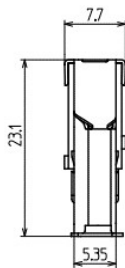
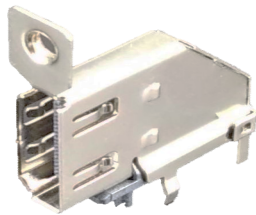

A 矢視図

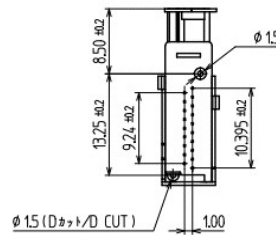

B 矢視図

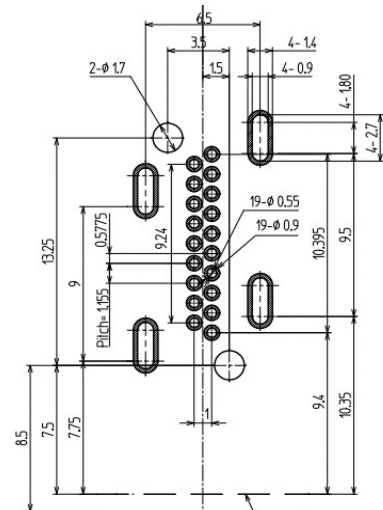
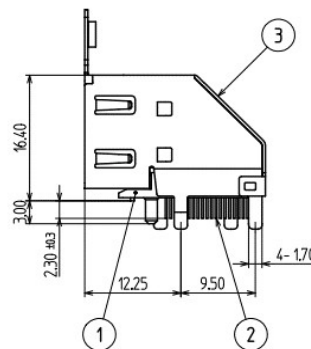
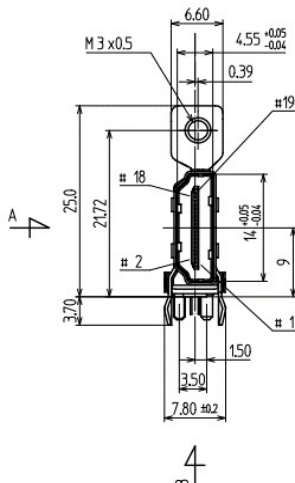

Dimensions of PC board holes / 参考基板孔寸法図

(Parts-side view, Tolerance all±0.05) / (部品側より見る 公差±0.05)

* 製品改良などにより記載性能、仕様の一部を予告なく変更する場合があります。

* As products are improved, changes may occur. Thus, specifications in directions are subject to change without previous notifications.

東北タツミ株式会社

〒101-0021東京都千代田区外神田二丁目4-4 第1電波ビル1F
TEL.(03)5577-5831 FAX.(03)5577-5832
E-mail:info@t-tatsumi.com
URL:http://www.t-tatsumi.com

TOHOKU TATSUMI CO., LTD.

2-4-4, Soto-Kanda, Chiyoda-ku, Tokyo, 101-0021, Japan,
Daiichidenpa building 1F
E-mail:info@t-tatsumi.com
URL:http://www.t-tatsumi.com