



USB CONNECTOR

部品番号
Part No.

YKF45-0080N

USB3.2 Gen2準拠 Type C 24P (RA)

■一般仕様

- ・定格 30V AC
5A(Vbus)
1.25A(Vconn, GND)
0.25A(その他)
- ・耐電圧 100V AC 1分
- ・絶縁抵抗 100V DC 1,000MΩ以上
- ・接触抵抗 40mΩ以下(100mA以下)
- ・動作耐久性 10,000回
- ・使用温度範囲 -20℃～+60℃

■General Specification

- ・Rating 30V AC
5A(Vbus)
1.25A(Vconn, GND)
0.25A(Others)
- ・Withstanding valtage 100V AC 1minute
- ・Insulation resistance 100V DC 1,000MΩ min.
- ・Contact resistance 40mΩ max
- ・Durability 10,000 times
- ・Practical temp -20℃～+60℃

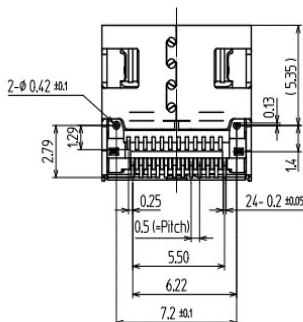
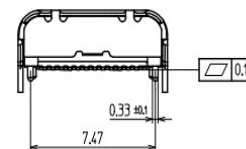
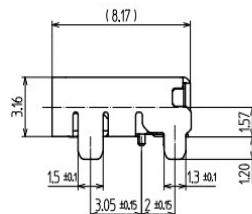
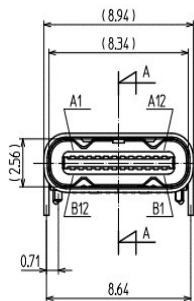
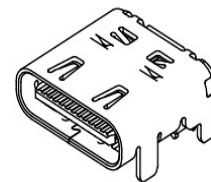
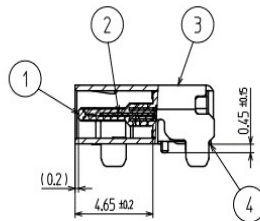
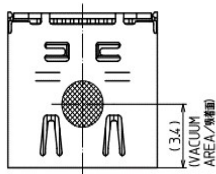

*製品改良などにより記載性能、仕様の一部を予告なく変更する場合があります。

*As products are improved, changes may occur. Thus, specifications in directions are subject to change without previous notificatons.

東北タツミ株式会社

〒101-0021東京都千代田区外神田二丁目4-4 第1電波ビル1F
TEL.(03)5577-5831 FAX.(03)5577-5832
E-mail:info@t-tatsumi.com
URL:http://www.t-tatsumi.com

TOHOKU TATSUMI CO., LTD.

2-4-4, Soto-Kanda, Chiyoda-ku, Tokyo, 101-0021, Japan,
Daiichidenpa building 1F
E-mail:info@t-tatsumi.com
URL:http://www.t-tatsumi.com