

A-A Sec / 断面図

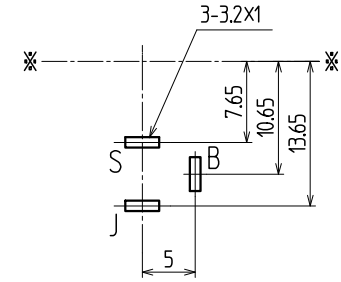

Dimensions of PC board holes / 参考基板孔

Tolerance / 公差 ALL±0.05

Soldering-side view / 半田面側より見る

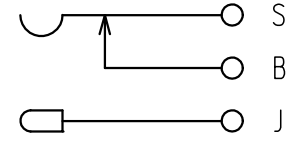
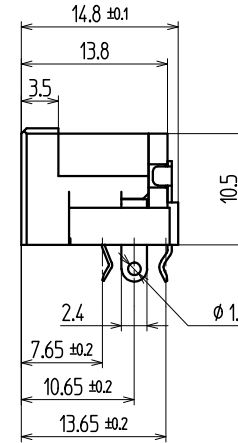
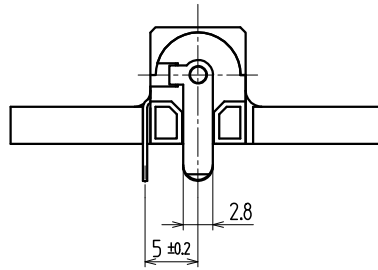
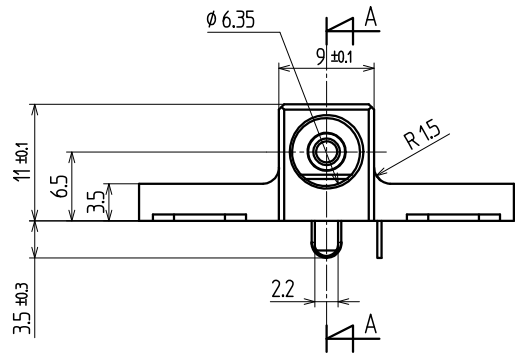

Circuit / 回路図

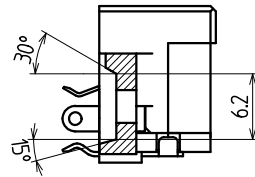
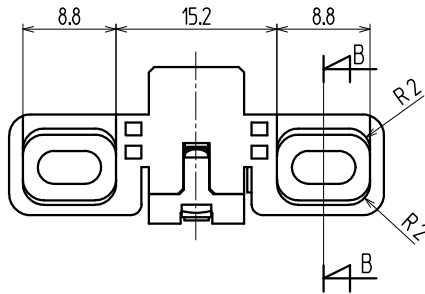

B-B Sec / 断面図

No.	PARTS NAME	Q'TY	MATERIAL	MAKER	No.	UL	FINISH	REMARKS
6	PIN CONTACT ピン端子	1	COPPER ALLOY 銅合金	10.4			TIN PLATED	
5	PIN ピン	1	COPPER ALLOY 銅合金				NICKEL PLATED	
4	BREAK CONTACT ブレイク端子	1	COPPER ALLOY 銅合金	10.4			SILVER PLATED	
3	SLEEVE CONTACT スリーブ端子	1	STAINLESS ステンレス	10.2			SILVER PLATED	
2	COVER カバー	1	PBT (GF30%) PBT (GF30%)	BLACK		94V-0		
1	HOUSING ハウジング	1	PBT (GF30%) PBT (GF30%)	BLACK		94V-0		

ALL DIMENSIONS IN () ARE FOR REFERENCES ONLY () 印は、参考寸法				TITLE 名称		DC POWER JACK 電源ジャック		ISSUED 出 図
APPROVED 責任者	CHECKED 照査者	DRAWN 製図者	DESIGNED 設計者	CODE No. コードNo.		KB0271A03DK2		/
				DRAWING No. 図番				
				PAGE ページ		REVISION 版数		
				CUSTOMER CODE ユーザーコード				

TOHOKU TATSUMI CO.,LTD.

TOLERANCE 寸法公差		X						
ALL	± 0.5	X						
over 以上	±	X						
under 未満	±	X						
ANGLE(DEG) 角 度	± 3°	X	MARK 記号	REVISIONS 改訂事項	DATE 日付	SIGN 担当		